



MACAGI SRL  
BENESSERE BAMBINO

FIT EASY  
ARTICOLO

104  
CODICE ARTICOLO

SCALA 1:25

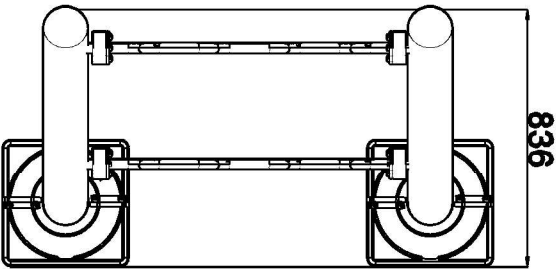
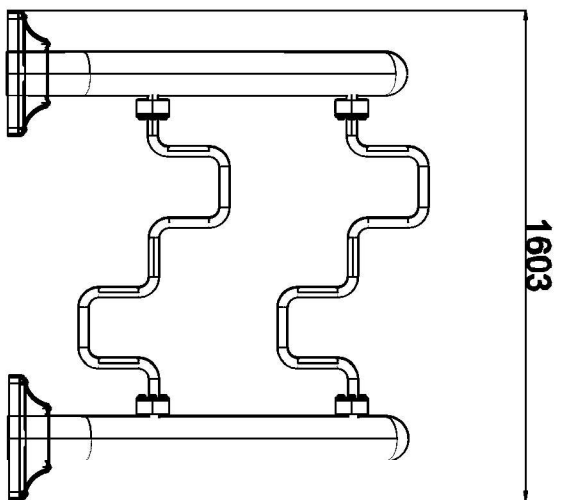
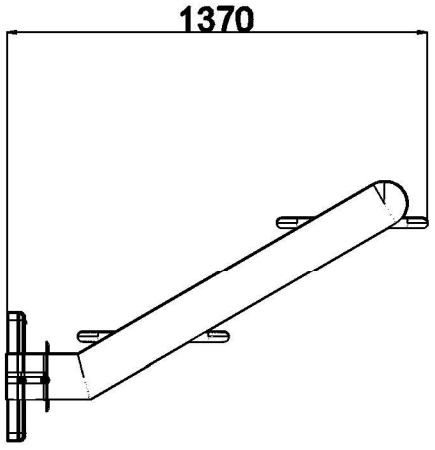

Quant. Pezzi	Figura	Denominazione	Finitura	Codice	Rev.
0	15/11/2017			104	
Revisione	Data	Prima Emissione	Motivo	Redatto	

≠	± 10 mm
∅	-
↔	-
Tolleranze Generali	

Riferim. TAV